

If you have questions or comments, contact us.

1-877-FNA-GAS1 (1-877-362-4271) • www.dewaltpw.com

INSTRUCTION MANUAL

DEWALT®

DH4240B
Pressure Washer

DH4240B PRESSURE WASHER

- | | |
|-----------------------------|---------------------------|
| A. Panel assembly | I. Starter grip |
| B. Nozzle Grommets | J. Engine |
| C. Professional Spray gun | K. Throttle control lever |
| D. Wheel | L. Choke control |
| E. Quick-connect spray wand | M. Fuel valve lever |
| F. Frame | N. Gas cap |
| G. Engine dipstick/oil plug | O. Handle assembly |
| H. Engine switch | P. High-pressure hose |
| | Q. High-pressure pump |

Engine

Refer to the engine instruction manual for location and operation of other engine controls.

Pump Specifications

GENERAL PUMP TX1510A

Oil Capacity: 14 Ounces

For best results, pump oil designed specifically for pressure washers is recommended, as these contain a rust inhibitor and an anti-foaming agent. If this oil is not available, an SAE 30W non-detergent oil may be used.

FIG. 1

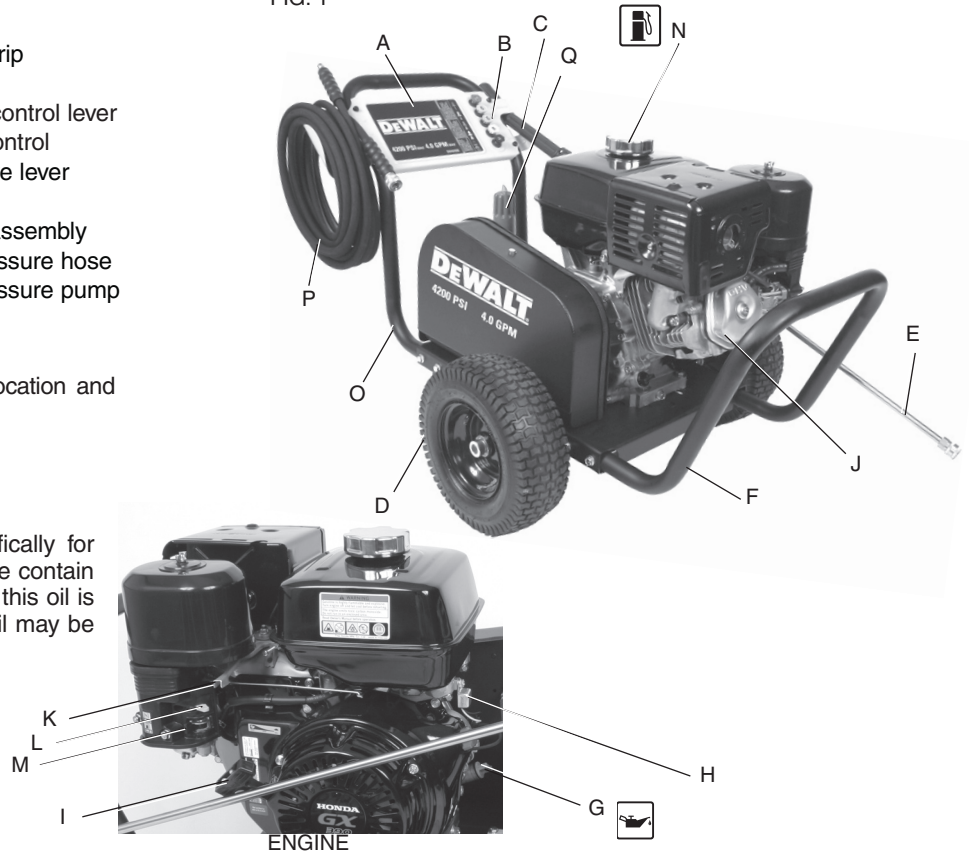

Specifications

MODEL	WEIGHT	HEIGHT	WIDTH	LENGTH	PSI MAX*	AVERAGE OPERATING PSI	GPM MAX*	AVERAGE OPERATING GPM	ENGINE
DH4240B	145 lbs	25.5"	28"	45"	4200 (29,958 kPa)	4100 (28,269 kPa)	4.0 (15.4 L/min)	3.9 (14.7L/min)	HONDA 389 cc OHV

* Maximum PSI and GPM ratings determined in accordance with the Pressure Washers Manufacturers Association (PWMA) standard PW101

Definitions: Safety Guidelines

The definitions below describe the level of severity for each signal word. Please read the manual and pay attention to these symbols.

⚠DANGER: Indicates an imminently hazardous situation which, if not avoided, **will** result in **death or serious injury**.

⚠WARNING: Indicates a potentially hazardous situation which, if not avoided, **could** result in **death or serious injury**.

⚠CAUTION: Indicates a potentially hazardous situation which, if not avoided, **may** result in **minor or moderate injury**.

NOTICE: Indicates a practice **not related to personal injury** which, if not avoided, **may** result in **property damage**.

IF YOU HAVE ANY QUESTIONS OR COMMENTS ABOUT THIS CONTACT US AT: www.dewaltpw.com or 1-877-FNA-GAS1 (1-877-362-4271)

Important Safety Instructions

⚠DANGER: Carbon Monoxide. Using an engine indoors can kill you in minutes. Engine exhaust contains high levels of carbon monoxide (CO), a poisonous gas you cannot see or smell. You may be breathing CO even if you do not smell engine exhaust.

⚠WARNING: This product and its exhaust contain chemicals known to the State of California to cause cancer, and birth defects and other reproductive harm.

- **NEVER** use an engine inside homes, garages, crawlspaces or other partly enclosed areas. Deadly levels of carbon monoxide can build up in these areas. Using a fan or opening windows and doors does **NOT** supply enough fresh air.
- **ONLY** use outdoors and far away from open windows, doors and vents. These openings can pull in engine exhaust.
- Even when the engine is used correctly, CO may leak into your home. **ALWAYS** use a battery-powered or battery backup CO alarm in your house. **Read and follow all directions for CO alarm before using.** If you feel sick, dizzy or weak at anytime, move to fresh air immediately. See a doctor. You could have carbon monoxide poisoning.

▲WARNING: Do not operate this unit until you read this instruction manual and the engine instruction manual for safety, operation and maintenance instructions.

▲WARNING: When using this product basic precautions should always be followed, including the following:

1. Read all instructions before using the product.
2. To reduce the risk of injury, close supervision is necessary when a product is used near children.
3. Know how to stop the product and bleed pressures quickly. Be thoroughly familiar with the controls.
4. Stay alert—watch what you are doing.
5. Do not operate the product when fatigued or under the influence of alcohol or drugs.
6. Keep operating area clear of all persons.
7. Do not overreach or stand on unstable support. Keep good footing and balance at all times.
8. Follow the maintenance instructions specified in the manual.

▲DANGER: RISK OF INJECTION OR SEVERE INJURY. KEEP CLEAR OF NOZZLE. DO NOT DIRECT DISCHARGE STREAM AT PERSONS. THIS PRODUCT IS TO BE USED ONLY BY TRAINED OPERATORS.

▲WARNING: This product may not be equipped with a spark-arresting muffler. If the product is not equipped and will be used around flammable materials or on land covered with materials such as agricultural crops, forest, brush, grass or other similar items, then an approved spark arrester must be installed and is legally required in the state of California. It is a violation of California statutes section 130050 and/or sections 4442 and 4443 of the California Public Resources Code, unless the engine is equipped with a spark arrester, as defined in section 4442, and maintained in effective working order. Spark arresters are also required on some U.S.

Forest Service land and may also be legally required under other statutes and ordinances.

▲WARNING: This product and its exhaust contain chemicals known to the State of California to cause cancer, and birth defects or other reproductive harm. In addition, some cleaning products and dust contain chemicals known to the State of California to cause cancer, and birth defects or other reproductive harm. Wash hands after handling.

SAVE THESE INSTRUCTIONS



▲DANGER: RISK OF EXPLOSION OR FIRE

WHAT CAN HAPPEN

- Spilled gasoline and it's vapors can become ignited from cigarette sparks, electrical arcing, exhaust gases and hot engine components such as the muffler.
- Heat will expand fuel in the tank which could result in spillage and possible fire explosion.
- Operating the pressure washer in an explosive environment could result in a fire.

HOW TO PREVENT IT

- Shut off engine and allow it to cool before adding fuel to the tank.
- Use care in filling tank to avoid spilling fuel. Move pressure washer away from fueling area before starting engine.
- Keep maximum fuel level 1/2" (12.7 mm) below bottom of filler neck to allow for expansion.
- Operate and fuel equipment in well-ventilated areas free from obstructions. Equip areas with fire extinguisher suitable for gasoline fires.

- Materials placed against or near the pressure washer can interfere with its proper ventilation features causing overheating and possible ignition of the materials.
- Muffler exhaust heat can damage painted surfaces, melt any material sensitive to heat (such as siding, plastic, rubber, vinyl or the pressure hose, itself), and damage live plants.
- Improperly stored fuel could lead to accidental ignition. Fuel improperly secured could get into the hands of children or other unqualified persons.
- Use of acids, toxic or corrosive chemicals, poisons, insecticides, or any kind of flammable solvent with this product could result in serious injury or death.
- Never operate pressure washer in an area containing dry brush or weeds.
- Always keep pressure washer a minimum of 4' (1.2 m) away from surfaces (such as houses, automobiles or live plants) that could be damaged from muffler exhaust heat.
- Store fuel in an OSHA approved container, in a secure location away from work area.
- Do not spray flammable liquids.



▲ DANGER: RISK TO BREATHING (ASPHYXIATION)
WHAT CAN HAPPEN **HOW TO PREVENT IT**

- Breathing exhaust fumes will cause serious injury or death! Engine exhaust contains carbon monoxide, an odorless and deadly gas.
- Some cleaning fluids contain substances which could cause injury to skin, eyes or lungs.
- Operate pressure washer in a well-ventilated area. Avoid enclosed areas such as garages, basements, etc.
- Never operate unit in or near a location occupied by humans or animals.
- Use only cleaning fluids specifically recommended for high-pressure washers. Follow manufacturers recommendations. Do not use chlorine bleach or any other corrosive compound.



⚠ DANGER: RISK OF FLUID INJECTION AND LACERATION

WHAT CAN HAPPEN

- Your pressure washer operates at fluid pressures and velocities high enough to penetrate human and animal flesh, which could result in amputation or other serious injury. Leaks caused by loose fittings or worn or damaged hoses can result in injection injuries. **DO NOT TREAT FLUID INJECTION AS A SIMPLE CUT!** See a physician immediately!

HOW TO PREVENT IT

- Inspect the high-pressure hose regularly. Replace the hose immediately if it is damaged, worn, has melted from contacting the engine, or shows any signs of cracks, bubbles, pinholes, or other leakage. Never grasp a high-pressure hose that is leaking or damaged.
- Never touch, grasp or attempt to cover a pinhole or similar water leak on the high-pressure hose. The stream of water IS under high pressure and WILL penetrate skin.
- Never place hands in front of nozzle.
- Direct spray away from self and others.
- Make sure hose and fittings are tightened and in good condition. Never hold onto the hose or fittings during operation.

- Do not allow hose to contact muffler.
- Never attach or remove wand or hose fittings while system is pressurized.
- When using replacement lances or guns with this pressure washer, **DO NOT** use a lance and/or lance/gun combination that is shorter in length than what was provided with this pressure washer as measured from the nozzle end of the lance to the gun trigger.
- To relieve system pressure, shut off engine, turn off water supply and pull gun trigger until water stops flowing.
- Use only accessories rated equal to or higher than the rating of the pressure washer.

- Injuries can result if system pressure is not reduced before attempting maintenance or disassembly.



⚠ DANGER: RISK OF INJURY FROM SPRAY

WHAT CAN HAPPEN

- High-velocity fluid spray can cause objects to break, propelling particles at high speed.
- Light or unsecured objects can become hazardous projectiles.

HOW TO PREVENT IT

- Always wear ANSI-approved Z87.1 safety glasses. Wear protective clothing to protect against accidental spraying.
- Never point wand at or spray people or animals.
- Always secure trigger lock when wand is not in service to prevent accidental operation.
- Never permanently secure trigger in pull-back (open) position.



⚠ DANGER: RISK OF UNSAFE OPERATION

WHAT CAN HAPPEN

- Unsafe operation of your pressure washer could lead to serious injury or death to you or others.

HOW TO PREVENT IT

- Do not use chlorine bleach or any other corrosive compound.
- Become familiar with the operation and controls of the pressure washer.
- Keep operating area clear of all persons, pets and obstacles.
- Do not operate the product when fatigued or under the influence of alcohol or drugs. Stay alert at all times.
- Never defeat the safety features of this product.
- Do not operate machine with missing, broken or unauthorized parts.
- Never leave wand unattended while unit is running.

- If proper starting procedure is not followed, engine can kickback causing serious hand and arm injury.
- The spray gun/wand is a powerful cleaning tool that could look like a toy to a child.
- Reactive force of spray will cause gun/wand to kickback, and could cause the operator to slip or fall or misdirect the spray. Improper control of gun/wand can result in injuries to self and others.
- If engine does not start after two pulls, squeeze trigger of gun to relieve pump pressure. Pull starter cord slowly until resistance is felt. Then pull cord rapidly to avoid kickback and prevent hand or arm injury.
- Keep children away from the pressure washer at all times.
- Do not overreach or stand on an unstable support.
- Do not use pressure washer while standing on a ladder.
- Grip gun/wand firmly with both hands. Expect the gun to kickback when triggered.



**⚠ DANGER: RISK OF INJURY OR PROPERTY DAMAGE
WHEN TRANSPORTING OR STORING**

WHAT CAN HAPPEN

- Fuel or oil can leak or spill and could result in fire or breathing hazard. Serious injury or death can result. Fuel or oil leaks will damage carpet, paint or other surfaces in vehicles or trailers.
- Oil could fill the cylinder and damage the engine if the unit is not stored or transported in an upright position.

HOW TO PREVENT IT

- If pressure washer is equipped with a fuel shut-off valve, turn the valve to the OFF position before transporting to avoid fuel leaks. If pressure washer is not equipped with a fuel shut-off valve, drain the fuel from tank before transporting. Only transport fuel in an OSHA-approved container. Always place pressure washer on a protective mat when transporting to protect against damage to vehicle from leaks. Always transport and store unit in an upright position. Remove pressure washer from vehicle immediately upon arrival at your destination.



▲ WARNING: RISK OF BURSTING

WHAT CAN HAPPEN

- Over inflation of tires could result in serious injury and property damage.

HOW TO PREVENT IT

- Use a tire pressure gauge to check the tires pressure before each use and while inflating tires; see the tire sidewall for the correct tire pressure.
NOTE: Air tanks, compressors and similar equipment used to inflate tires can fill small tires similar to these very rapidly. Adjust pressure regulator on air supply to no more than the rating of the tire pressure. Add air in small increments and frequently use the tire gauge to prevent over inflation.

- High-velocity fluid spray directed at pneumatic tire sidewalls (such as found on automobiles, trailers and the like) could damage the sidewall resulting in serious injury.

- On pressure washers rated above 1600 psi (11032 kPa) use the widest fan spray (40° nozzle) and keep the spray a minimum of 8" (20 cm) from the pneumatic tire sidewall. Do not aim spray directly at the joint between the tire and rim.



▲ WARNING: RISK OF HOT SURFACES

WHAT CAN HAPPEN

- Contact with hot surfaces, such as engines exhaust components, could result in serious burn.

HOW TO PREVENT IT

- During operation, touch only the control surfaces of the pressure washer. Keep children away from the pressure washer at all times. They may not be able to recognize the hazards of this product.



⚠ WARNING: RISK FROM MOVING PARTS

WHAT CAN HAPPEN

- Moving parts such as the pulley, flywheel, and belt can cause serious injury if they come into contact with you or your clothing.

HOW TO PREVENT IT

- Never operate with guards or covers which are damaged or removed.
- Keep your hair, clothing, and gloves away from moving parts. Loose clothes, jewelry, or long hair can be caught in moving parts.



⚠ WARNING: RISK OF CHEMICAL BURN

WHAT CAN HAPPEN

- Use of acids, toxic or corrosive chemicals, poisons, insecticides, or any kind of flammable solvent with this product could result in serious injury or death.

HOW TO PREVENT IT

- Do not spray acids, gasoline, kerosene, or any other flammable materials with this product. Use only household detergents, cleaners and degreasers recommended for use with pressure washers.
- Wear protective clothing to protect eyes and skin from contact with sprayed materials.



⚠ WARNING: RISK OF ELECTRICAL SHOCK

WHAT CAN HAPPEN

- Spray directed at electrical outlets or switches, or objects connected to an electrical circuit, could result in a fatal electrical shock.

HOW TO PREVENT IT

- Unplug any electrically operated product before attempting to clean it. Direct spray away from electric outlets and switches.



⚠ WARNING: RISK OF INJURY FROM LIFTING

WHAT CAN HAPPEN

- Serious injury can result from attempting to lift too heavy an object.

HOW TO PREVENT IT

- The pressure washer is too heavy to be lifted by one person. Obtain assistance from others before lifting.

SAVE THESE INSTRUCTIONS FOR FUTURE USE

INSTALLATION

Pressure Washer Assembly (Fig. 1)

Verify the fuel and oil tanks are empty prior to installing the handle. Refer to the Honda engine owner's manual for details. If the fuel and oil tanks are not empty, raise the machine and provide adequate support before performing this installation.

Always provide adequate support before performing these operations.

Tools required (Not included):

- 1/2" (13 mm) open-end wrench
- 1/2" (13 mm) socket or 1/2" (13 mm) wrench

Hardware (Included with your machine):

- 1 Handle (F)
- 1 Leg Assembly (DD)
- 4 Bolts (EE)
- 8 Flat Washers (FF)
- 4 Nuts (GG)

1. Remember to secure/support the machine before removing or loosening the bolts. Use the wrench and socket to remove the leg assembly bolts (EE, GG).
2. Position/slide the handle (O) into the frame (F) and on the outside of each side of the foot bracket assembly (DD).
3. Align the holes in the Handle with the mounting holes in the frame and leg assemblies.
4. Fasten the handle (O) to the foot bracket (DD) and frame (F) with the hardware (EE, FF, GG) from step 1 as shown and tighten each nut until snug.

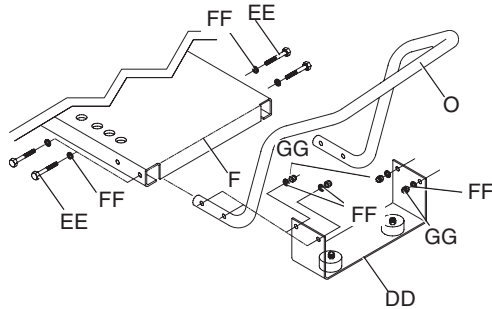

5. Attach high-pressure hose (P) to spray gun. Make sure it is secure.

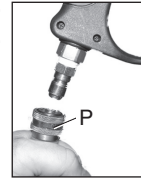

6. Connect wand (E) to spray gun. Make sure connection is secure.

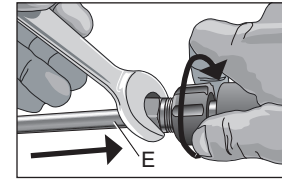

7. Place the grommets (B) onto the panel assembly (A) and push into place.

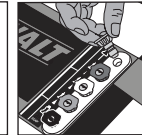
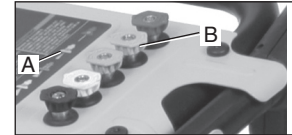

8. Remove the five colored quick-connect nozzles from the plastic bag and insert them into correct grommet on the nozzle holder. Nozzles are color coded to match colored nozzles on panel assembly.

NOTE: The high-pressure pump was filled with oil at the factory. Always check oil level before using (refer to **Maintenance** for more information).

⚠WARNING: Risk of bursting. Use a tire pressure gauge to check the tires pressure before each use and while inflating tires; see the tire sidewall for the correct tire pressure.

NOTE: Air tanks, compressors and similar equipment used to inflate tires can fill small tires similar to these very rapidly. Adjust pressure regulator on air supply to no more than the rating of the tire pressure. Add air in small increments and frequently use the tire gauge to prevent over inflation.

9. The pressure washer is now ready for handling. Make sure to follow the Owner's Manual instructions before starting the pressure washer.

OPERATION

Pressure Adjustments

The pressure setting is preset at the factory to achieve optimum pressure and cleaning. To lower the pressure, follow these instructions.

1. Back away from the surface to be cleaned. The further away you are, the less the pressure will be on the surface to be cleaned.
2. Change to the 40° nozzle (white). This nozzle delivers a less powerful stream of water and a wider spray pattern. Refer to **Spray Wand Nozzles**.





NOTICE: DO NOT attempt to increase pump pressure. A higher pressure setting than the factory set pressure may damage pump.

3. Reduce the speed of the gasoline engine (RPM). Slow the engine down and the water pressure will go down with it.

Spray Wand Nozzles (Fig. 1)

The nozzles for the spray wand are stored in the nozzle holder (B) on the panel assembly (A). Colors on the panel identify nozzle location and spray pattern. Refer to the following chart to choose the correct nozzle for the job to be performed.

Nozzle Color	Spray Pattern	Uses	Surfaces*
Red	0° 	powerful pinpoint for very intense cleaning	metal or concrete; DO NOT use on wood

Yellow	15° 	intense cleaning of small areas	metal, concrete or wood
Green	25° 	intense cleaning of larger areas	metal, concrete or wood
White	40° 	covers wide areas of cleaning	metal, concrete, wood or vinyl
Black	low pressure 	applies cleaning solutions	metal, concrete, wood or vinyl

* **NOTICE:** The high-pressure spray from your pressure washer is capable of causing damage to surfaces such as wood, glass, automobile paint, auto striping and trim, delicate objects such as flowers and shrubs. Before spraying, check the item to be cleaned to assure yourself that it is strong enough to resist damage from the force of spray.

CHANGING NOZZLES ON SPRAY WAND

⚠ DANGER: Risk of fluid injection. Do not direct discharge stream toward persons, unprotected skin, eyes or any pets or animals. Serious injury will occur.

▲WARNING: Flying objects could cause risk of serious injury. DO NOT attempt to change nozzles while pressure washer is running. Turn engine off before changing nozzles.

1. Pull quick-connect coupler back and insert nozzle.
2. Release quick-connect coupler and twist nozzle to make sure it is secure in coupler.

▲WARNING: Flying object could cause risk of serious injury. Ensure nozzle is completely inserted in quick-connect socket and quick-connect snap ring is fully engaged (forward) before squeezing gun trigger.

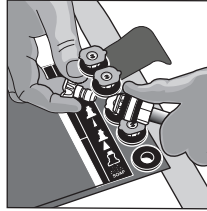

Chemicals and Cleaning Solvents

Applying chemicals or cleaning solvents is a low-pressure operation.

NOTE: Use only soaps and chemicals designed for pressure washer use. **Do not use bleach.**

TO APPLY CHEMICALS AND SOLVENTS

1. Press chemical hose (S) onto barbed fitting located near high pressure hose connection of pump as shown.
2. Place the other end of chemical hose with filter on it into the container holding chemical/cleaning solution.

NOTE: For every 10 gallons (38 liters) of water pumped 1 gallon (3.8 liters) of chemical/cleaning solution will be used.

3. Install low-pressure (black) nozzle into quick connect fitting of spray wand, refer to **Spray Wand Nozzles**. **NOTE:** Chemicals and soaps will not siphon if the black soap nozzle is not installed on the spray wand.

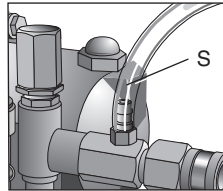

4. After use of chemicals, place chemical hose into container of clean water and draw clean water through chemical injection system to rinse system thoroughly. If chemicals remain in the pump it could be damaged. Pumps damaged due to chemicals will not be covered under warranty.

Starting

▲WARNING: To reduce the risk of injury, read the pressure washer instruction manual and the engine instruction manual before starting pressure washer.

▲DANGER: Risk of fluid injection and laceration. When using the high-pressure setting, DO NOT allow the high-pressure spray to come in contact with unprotected skin, eyes, or with any pets or animals. Serious injury will occur.

- Your washer operates at fluid pressures and velocities high enough to penetrate human and animal flesh, which could result in amputation or other serious injury. Leaks caused by loose fittings or worn or damaged hoses can result in injection injuries. DO NOT TREAT FLUID INJECTION AS A SIMPLE CUT! See a physician immediately!

▲WARNING: Risk of fire, asphyxiation and burning. NEVER fill fuel tank when engine is running or hot. Do not smoke when filling fuel tank.

- NEVER fill fuel tank completely. Fill tank to 1/2" (12.7 mm) below bottom of filler neck to provide space for fuel expansion. Wipe any fuel spillage from engine and equipment before starting engine.
- NEVER run engine indoors or in enclosed, poorly ventilated areas. Engine exhaust contains carbon monoxide, an odorless and deadly gas.
- DO NOT let hoses come in contact with very hot engine muffler during or immediately after use of your pressure washer. Damage to hoses from contact with hot engine surfaces will NOT be covered by warranty.

NOTICE: NEVER pull water supply hose to move pressure washer. This could damage hose and/or pump inlet.

- DO NOT use hot water, use cold water only.
- NEVER turn water supply off while pressure washer engine is running or damage to pump will result.
- DO NOT stop spraying water for more than two minutes at a time. Pump operates in bypass mode when spray gun trigger is not pressed. When the temperature inside the pump rises too high the thermal relief valve (T) will open and release a gush of water in an effort to lower the temperature inside the pump. The thermal relief valve will then close. If pump is left in bypass mode for more than two minutes internal components of the pump can be damaged.

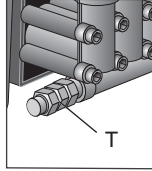

START-UP PROCEDURE

1. In a well-ventilated outdoor area, add fresh, high-quality, unleaded gasoline with a pump octane rating of 86 or higher. Do not overfill. Wipe up spilled fuel before starting the engine. Refer to engine instruction manual for correct procedure.
2. Check engine oil level. Refer to the engine instruction manual for correct procedure.
3. Connect the water hose to the water source. Turn the water source on to remove all air from the hose. When a steady stream of water is present, turn the water source off.
4. Verify the filter screen (U) is in water inlet of pump. The cone side faces out.
5. Connect the cold water source (V) to pump inlet.
NOTE: Water source must provide a minimum of 5 gallons per minute at 20 psi (138 kPa).

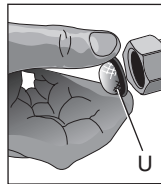

▲WARNING: To reduce the possibility of contamination always protect against backflow when connected to a potable water system.

6. Connect high-pressure hose (P) to pump outlet.
7. If applying a chemical or cleaning solution, refer to **Chemicals and Cleaning Solvents**.
8. Turn the water source on.

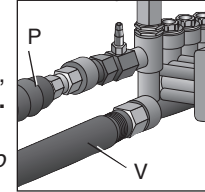

NOTICE: Risk of property damage. Failure to do so could cause damage to the pump.

9. Remove all air from the pump and high pressure hose by depressing trigger until a steady stream of water is present.
10. Turn the engine ON/OFF switch (H) to the ON position.
11. Place the fuel valve lever (M) in the ON position.
12. If the engine is cold, move the choke (K) to the CLOSED position as shown.

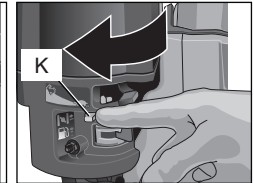
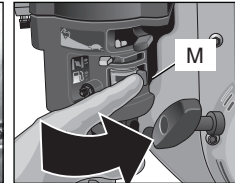
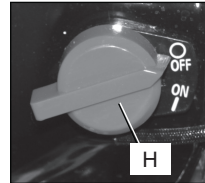

13. **▲WARNING:** Risk of unsafe operation. Pull starter grip slowly until resistance is felt. Then pull starter grip (I) rapidly to avoid kickback and prevent hand or arm injury.

NOTE: Do not allow the starter grip to snap back. Return it gently by hand.

▲WARNING: Risk of unsafe operation. If engine does not start after two pulls, squeeze trigger of gun to relieve pump pressure. Pull starter cord slowly until resistance is felt. Then pull cord rapidly to avoid kickback and prevent hand or arm injury.

NOTE: If the oil level in the engine is low, the engine will not start. If the engine does not start, check the oil level and add oil as needed.

14. As the engine warms up, move the choke to the OPEN position.

15. Depress trigger on gun to start water flow.

▲WARNING: Risk of unsafe operation. Stand on a stable surface and grip gun/wand firmly with both hands. Expect the gun to kickback when triggered.

16. Release trigger to stop water flow.

▲DANGER: Risk of injury from spray. Engage the trigger lock (X) when gun is not in use to prevent accidental spraying.

17. Adjust spray for the task being performed by changing quick connect nozzle. Refer to **Spray Wand Nozzles**.

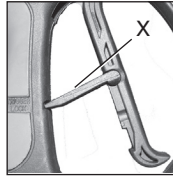
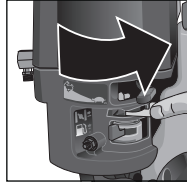

Shutting Down

1. If chemicals were applied, place the chemical hose into a container of clean water and draw clean water through chemical injection system to rinse system thoroughly.

NOTICE: Risk of property damage Failure to do so could cause damage to the pump.

2. Place the engine ON/OFF switch (H) to the OFF Position.

3. Place the fuel valve lever (M) in the OFF position.

NOTICE: Risk of property damage. NEVER turn water supply off while pressure washer engine is running or damage to pump will result.

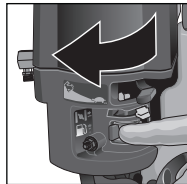

4. Turn water source off.

5. Pull trigger on spray gun to relieve any water pressure in hose or spray gun.

6. Refer to **Storage** for proper storage procedures.

MAINTENANCE

▲WARNING: Risk of burning. When performing maintenance, you may be exposed to hot surfaces, water pressure or moving parts that can cause serious injury or death.

▲WARNING: Risk of fire. Always disconnect, spark plug wire, let the engine cool and release all water pressure before performing any maintenance or repair. The engine contains flammable fuel. Do not smoke or work near open flames while performing maintenance. To ensure efficient operation and longer life of your pressure washer, a routine maintenance schedule should be prepared and followed. If the pressure washer is used in unusual conditions, such as high temperatures or dusty conditions, more frequent maintenance checks will be required.

Engine

Consult the engine instruction manual for the manufacturer's recommendations for any and all maintenance.

NOTE: The pressure washer frame is equipped with an oil drain hole to help make changing the engine oil easier.

Pump

NOTE: The pump was filled with oil at the factory.

Change pump oil after the first 50 hours of operation and every 300 hours thereafter.

TO CHECK OIL

The oil level should come to the dot in the middle of the sight glass (AA).

HOW TO CHANGE PUMP OIL

1. Loosen pump dipstick/oil plug (BB).
2. Place a container under the oil drain plug (CC).
3. Remove pump oil drain plug.
4. After oil is drained, replace oil drain plug. Tighten securely.
5. Remove pump dipstick/oil plug and fill with 30W non-detergent oil.
6. Replace pump dipstick/oil plug and tighten securely.

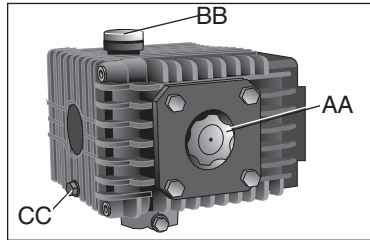

Nozzle Cleaning

If the nozzle becomes clogged with foreign materials, such as dirt, excessive pressure may develop. If the nozzle becomes partially clogged or restricted, the pump pressure will pulsate. Clean the nozzle immediately using the nozzle kit supplied and the following instructions:

1. Shut off the pressure washer and turn off the water supply.
2. Pull trigger on gun handle to relieve any water pressure.
3. Disconnect the spray wand from the gun.
4. Remove the high-pressure nozzle from the spray wand. Remove any obstructions with the nozzle cleaning tool (Y) provided and back flush with clean water.
5. Direct water supply into spray wand to back flush loosened particles for 30 seconds.
6. Reassemble the nozzle to the wand.

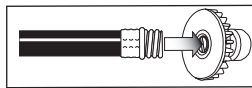
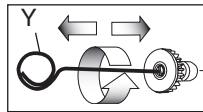

7. Reconnect spray wand to gun then turn on water supply.
8. Start pressure washer and place spray wand into high pressure setting to test.

To Clean the Water Inlet Filter

This filter screen (U) should be checked periodically and cleaned if necessary.

1. Remove the filter screen (U) by grasping the end and removing it from water inlet of pump.
2. Clean filter by flushing it with water on both sides.
3. Reinsert filter into water inlet of pump. Cone side faces out.

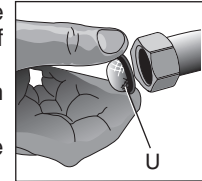

NOTE: Do not operate pressure washer without filter properly installed.

To Remove Tires

1. Using a 1/8" hex head wrench loosen set screw in hub collar.
2. Slide hub collar from axle and remove the tire.

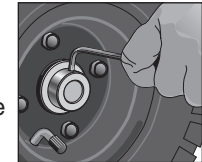

STORAGE

Engine

Consult the engine instruction manual for the manufacturer's recommendations for storage.

Pump

The manufacturer recommends using a pump protector/winterizer, such as DEWALT winterizer (DP80) when storing the unit for more than 30 days and/or when freezing temperatures are

expected. DEWALT winterizer (DP80) is available at the store where the pressure washer was purchased. If a pump protector/winterizer is not available, RV antifreeze can be used as outlined in the following steps.

NOTE: Using a pump protector/winterizer or RV antifreeze helps to provide proper lubrication to the internal seals of the pump regardless of temperature or environment.

1. Obtain a funnel, 6 oz. (170 mL) of RV antifreeze and 16–36" (40–91 cm) of garden hose with a male hose connector attached to one end.

NOTICE: Risk of property damage. Use only RV antifreeze. Any other antifreeze is corrosive and can damage pump.

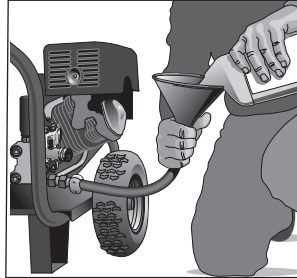

2. Disconnect spark plug wire.
3. Connect length of garden hose to water inlet of pump.
4. Add RV antifreeze to hose as shown.
5. Pull engine starter rope slowly several times until antifreeze comes out of high-pressure hose connection of pump.
6. Remove garden hose from water inlet of pump.
7. Reconnect spark plug wire.

Pressure Washer

1. Drain all water from high-pressure hose, coil it and store it in cradle of the pressure washer handle.
2. With nozzle pointed down and the spray gun and wand in a vertical position, squeeze trigger to drain all water from spray gun and wand. Store in gun holder.

3. Store chemical hose so it is protected from damage.

▲CAUTION: Risk of personal injury. Avoid placing hands between handle and frame when assembling to prevent pinching.

NOTICE: Risk of property damage. Always store and transport unit in an upright position.

ACCESSORIES

Recommended accessories for use with your tool are available for purchase from your local dealer or authorized service center. If you need assistance in locating any accessory for your tool, please contact the FNA Group at www.dewaltpw.com, 1825 Greenleaf Avenue, Elk Grove Village, IL 60007, or call (877) FNA-GAS1.

▲DANGER: Risk of fluid injection. When using replacement lances or guns with this pressure washer, DO NOT use a lance and/or lance/gun combination that is shorter in length than what was provided with this pressure washer as measured from the nozzle end of the lance to the gun trigger.

▲WARNING: The use of any other accessory not recommended for use with this tool could be hazardous. Use only accessories rated equal to or higher than the rating of the pressure washer.

SERVICE INFORMATION

Please have the following information available for all service calls:

Model Number _____ Serial Number _____

Date and Place of Purchase _____

Repairs

To assure product SAFETY and RELIABILITY, repairs, maintenance and adjustment should be performed by a FNA factory service center, a FNA authorized service center or other qualified service personnel. Always use identical replacement parts.

Limited Warranty

This pressure washer is warranted for three years from date of purchase. We will repair, without charge, any defects due to faulty materials or workmanship. This warranty does not cover parts that are damaged through misuse or abuse, or parts which must be replaced from time to time due to normal pressure washer operation. Normal wear parts include, but are not limited to, the engine air filter, spark plug, pump valve seals and O rings. This warranty does not apply to accessories or damage caused where repairs have been made or attempted by a repair center not authorized by FNA. This warranty gives you specific legal rights and you may have other rights which vary in certain states or provinces. For further details of warranty coverage and warranty repair information, visit www.dewalt.com and click on Service and Support or call 1-877-FNA-GAS1 (1-877-362-4271).

LATIN AMERICA: This warranty does not apply to products sold in Latin America. For products sold in Latin America, see country specific warranty information contained either in the packaging, call the local company or see website for warranty information.

FREE WARNING LABEL REPLACEMENT: If your warning labels become illegible or are missing, call 1-877-FNA-GAS1 (1-877-362-4271) for a free replacement.

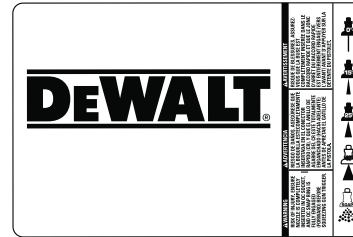

AVERTISSEMENT

RISQUES D'INCENDIE OU D'EXPLOSION. ARRÊTEZ LE MOTEUR AVANT D'AJOUTER DU CARBURANT. VOTRE AIRE DE TRAVAIL DOIT ÊTRE LIBRE DE MATIÈRES COMBUSTIBLES. ÉVITEZ DE VAPORISER DES LIQUIDES INFLAMMABLES.

RISQUE DE RESPIRATION. LES FUMÉES D'ÉCHAUFFEMENT PEUVENT CAUSER LA MORT. POUR USAGER À L'EXTÉRIEUR, ÉQUIPEMENT TRAVAILLÉ DANS UNE AIRE BIEN VENTILÉE.

AVERTISSEMENT

RISQUE DE MANGONNES LES RISQUES DE BLESSURES. UTILISATEUR DOIT TOUJOURS LIRE ET COMPRENDRE LE GUIDE D'UTILISATION, À L'INTÉRIEUR DU MOTEUR.

RISQUE D'INJECTION OU DE FLUIDE. LE JET DE FLUIDE PEUT PÉNÉTRER LA PEAU ET CAUSER DES BLESSURES GRAVES. NÉCESSAIRE IMMÉDIATEMENT LES SOINS D'UN MÉDECIN.

RISQUE DE BLESSURES CAUSÉES PAR LA VAPORISATION. LE JET DE VAPORISATION PEUT FAIRE PROPAGER DES OBJETES. PORTER TOUJOURS DES LUNETTES DE PROTECTION HOMOLOGUÉES ANSI Z87.1.

RISQUE DE BLESSURES CHIMIQUES. N'UTILISEZ JAMAIS D'ACIDES OU DE PRODUITS CORROSIFS OU TOXIQUES. UTILISEZ SEULEMENT DES PRODUITS DE NETTOYAGE CONÇUS POUR L'APPAREIL DE LAVAGE. TOUJOURS PORTER DES ÉQUIPEMENTS DE PROTECTION PERSONNELLE APPROPRIÉS.

RISQUE D'ÉLECTROCUTION. NE JERREZ JAMAIS LE JET DE VAPORISATION VERS UN APPAREIL ÉLECTRIQUE NI VERS UNE PRISE DE COURANT ÉLECTRIQUE.

RISQUE D'UNE UTILISATION NON SÉCURITAIRE. GARDEZ LES ENFANTS ÉLOIGNÉS DE CET APPAREIL. STABILISEZ LE PISTOLET À LA MAIN AVANT DE S'OPÉRER.

RISQUE DE SURFACES CHAUDES. ÉVITEZ TOUT CONTACT AVEC LES COMPOSANTES CHAUDES DU MOTEUR. NE PERMETTEZ PAS À VOS DOIGTS D'ÊTRE EN CONTACT AVEC LE SURCROQUIS CHAUD DU MOTEUR LORS DE L'UTILISATION OU TOUT DE SUITE APRÈS.

RISQUE DE BLESSURES. POIGES MOBILES. NE PAS UTILISER LORSQUE LE COUVERCLE EST ENLEVÉ.

RISQUE D'ÉCHAUFFEMENT DE PNEU. GONFLES LES PNEUS LÉGEREMENT JUSQU'À LA PRESSION INDICÉE SUR LEUR CÔTÉ. LIRE LE MODE D'EMPLOI.

RISQUE DE LÉSIONS. VÉRIFIER ET TENDRE LA MANIVELLE À HAUTE PRESSION AVANT CHAQUE UTILISATION ET LE REMPLACER SI ENDOMMAGÉ.

PELIGRO

RISQUE DE INCENDIO O EXPLOSION. APAGAR EL MOTOR ANTES DE AÑADIR COMBUSTIBLE. MANTENER EL ÁREA DE TRABAJO LIBRE DE MATERIAS COMBUSTIBLES. NO USAR PARA ROZAR LÍQUIDOS INFLAMABLES.

RISGO A LA RESPIRACION. LOS GASES DEL ESCAPE DEL MOTOR PUEDEN CAUSAR LA MUERTE. PARA USARSE SOLO EN EXTERIORES. TRABAJE EN ÁREAS BIEN VENTILADAS.

AVERTENCIA

PARA REDUCIR EL RIESGO DE LESIONES, EL USUARIO DEBE LEER Y ENTENDER EL MANUAL DE INSTRUCCIONES. GUARDAR EN EL MOTOR.

RISGO DE INYECCION DE FLUIDO. EL CHORO DEL FLUIDO PUEDE PENETRAR LA PIEL Y CAUSAR LESIONES SERIAS QUE REQUIERAN TRATAMIENTO MEDICO INMEDIATO.

RISGO DE LESIONES POR EL CHORO. EL CHORO PUEDE PROPULSAR OBJETOS. SIEMPRE USAR GAFAS DE SEGURIDAD QUE CUMPLAN CON LA NORMA Z87.1 DE ANSI.

RISGO DE QUEMADURAS QUIMICAS. NUNCA ROZAR ACIDOS NI SUSTANCIAS QUIMICAS CORROSIVAS O TOXICAS. SOLO USAR PRODUCTOS LIMPIADORES FORMULADOS PARA LAVADORES A PRESION.

RISGO DE ELECTROCUCION. NUNCA DIRIGIR EL CHORO HACIA DISPOSITIVOS ELECTRICOS NI HACIA CONTACTORES.

RISGO DE OPERACION INSEGURA. MANTENER A LOS NIÑOS ALEJADOS DE ESTE EQUIPO. ESTABILIZAR LA PISTOLA/FUNCIÓN ANTES DE USAR.

RISGO DE SUPERFICIES CALIENTES. EVITAR EL CONTACTO CON LAS COMPONENTES CALIENTES DEL ESCAPE DEL MOTOR. NO PERMITA QUE LAS MANOS ENTREN EN CONTACTO CON EL ESCAPEADOR DEL MOTOR DURANTE EL USO. PRESTADOR CALIENTE.

RISGO DE LÉSIONES. PARTES EN MOVIMIENTO. NO OPERAR CON LA CUBIERTA PROTECTORA REMOVIDA.

RISGO DE CALLEJO DEL PNEUMÁTICO. INFLA LOS PNEUMÁTICOS LENTAMENTE HASTA ALCANZAR LA PRESIÓN APTA PARA EL FUNCIONAMIENTO, INDICADA EN EL NEUMÁTICO. LEA EL MANUAL DE INSTRUCCIONES.

RISGO DE LÉSIONES. CONTROLA LA MANIVELA DE ALTA PRESIÓN ANTES DE CADA USO Y REEMPLAZALA SI ESTÁ DAÑADA.

AVERTISSEMENT

RISQUE DE INCENDIE OU D'EXPLOSION. ARRÊTEZ LE MOTEUR AVANT D'AJOUTER DU CARBURANT. VOTRE AIRE DE TRAVAIL DOIT ÊTRE LIBRE DE MATIÈRES COMBUSTIBLES. ÉVITEZ DE VAPORISER DES LIQUIDES INFLAMMABLES. NE PAS UTILISER LORSQUE LE COUVERCLE EST ENLEVÉ.

AVERTISSEMENT

RISQUE D'INCENDIE OU D'EXPLOSION. ARRÊTEZ LE MOTEUR AVANT D'AJOUTER DU CARBURANT. VOTRE AIRE DE TRAVAIL DOIT ÊTRE LIBRE DE MATIÈRES COMBUSTIBLES. ÉVITEZ DE VAPORISER DES LIQUIDES INFLAMMABLES.

AVERTISSEMENT

RISQUE D'INCENDIE OU D'EXPLOSION. ARRÊTEZ LE MOTEUR AVANT D'AJOUTER DU CARBURANT. VOTRE AIRE DE TRAVAIL DOIT ÊTRE LIBRE DE MATIÈRES COMBUSTIBLES. ÉVITEZ DE VAPORISER DES LIQUIDES INFLAMMABLES.

AVERTISSEMENT

RISQUE D'INCENDIE OU D'EXPLOSION. ARRÊTEZ LE MOTEUR AVANT D'AJOUTER DU CARBURANT. VOTRE AIRE DE TRAVAIL DOIT ÊTRE LIBRE DE MATIÈRES COMBUSTIBLES. ÉVITEZ DE VAPORISER DES LIQUIDES INFLAMMABLES.

AVERTISSEMENT

RISQUE D'INCENDIE OU D'EXPLOSION. ARRÊTEZ LE MOTEUR AVANT D'AJOUTER DU CARBURANT. VOTRE AIRE DE TRAVAIL DOIT ÊTRE LIBRE DE MATIÈRES COMBUSTIBLES. ÉVITEZ DE VAPORISER DES LIQUIDES INFLAMMABLES.

AVERTISSEMENT

RISQUE D'INCENDIE OU D'EXPLOSION. ARRÊTEZ LE MOTEUR AVANT D'AJOUTER DU CARBURANT. VOTRE AIRE DE TRAVAIL DOIT ÊTRE LIBRE DE MATIÈRES COMBUSTIBLES. ÉVITEZ DE VAPORISER DES LIQUIDES INFLAMMABLES.

AVERTISSEMENT

RISQUE D'INCENDIE OU D'EXPLOSION. ARRÊTEZ LE MOTEUR AVANT D'AJOUTER DU CARBURANT. VOTRE AIRE DE TRAVAIL DOIT ÊTRE LIBRE DE MATIÈRES COMBUSTIBLES. ÉVITEZ DE VAPORISER DES LIQUIDES INFLAMMABLES.

AVERTISSEMENT

RISQUE D'INCENDIE OU D'EXPLOSION. ARRÊTEZ LE MOTEUR AVANT D'AJOUTER DU CARBURANT. VOTRE AIRE DE TRAVAIL DOIT ÊTRE LIBRE DE MATIÈRES COMBUSTIBLES. ÉVITEZ DE VAPORISER DES LIQUIDES INFLAMMABLES.

Glossary

Bypass mode: Allows water to re-circulate within pump when the gun trigger is not pulled.

Chemical hose: Feeds cleaning agents into the pump to mix with the water. Refer to **Chemicals and Cleaning Solvents**.

Chemical injection system: Mixes cleaners or cleaning solvents with water to improve cleaning effectiveness.

Choke control: Opens and closes carburetor choke valve.

CU: Cleaning Units. GPM multiplied by psi. (GPM x PSI = CU)

Fuel valve lever: Opens/closes connection between fuel tank and carburetor.

GPM: Gallons Per Minute. The unit of measure for the flow rate of water.

PSI: Pounds per Square Inch. The unit of measure for water pressure. Also used for air pressure, hydraulic pressure, etc.

kPa (kilopascal): Metric pressure measurement. 1 kilopascal equal 1000 pascals.

Quick-connect spray wand: Allows the user to quickly change out high-pressure nozzles. Refer to Spray Wand Nozzles.

Thermal relief valve: When the temperature inside the pump rises too high the valve will open and release a gush of water in an effort to lower the temperature inside the pump. The valve will then close.

Water supply: All pressure washers must have a source of water. The minimum requirements for a water supply are 20 psi (138 kPa) and 5 gallons per minute.

Troubleshooting Guide

This section provides a list of the more frequently encountered malfunctions, their causes and corrective actions. The operator or maintenance personnel can perform some corrective actions, and others may require the assistance of a qualified FNA technician or your dealer.

Problem	Code
Engine will not start <i>(refer to the engine's instruction manual for further engine troubleshooting)</i>	1, 2, 3, 4, 5, 6, 7, 8, 36
No or low pressure (initial use).....	9, 10, 11, 12, 13, 14, 15, 16
Will not draw chemicals.....	16, 17, 18, 19, 20, 21
No or low pressure (after period of normal use).....	22, 23, 24
Water leaking at gun/spray wand connection.....	25, 26
Water leaking at pump.....	25, 26, 27, 28
Oil leaking at pump.....	29, 30, 31, 32, 33, 34, 35
Pump Pulsates.....	12

Troubleshooting Codes

CODE	POSSIBLE CAUSE	POSSIBLE SOLUTION
1	No fuel.	Add fuel.
2	Low oil.	Add required amount of oil.
3	Pressure builds up after two pulls on the recoil starter or after initial use.	Squeeze gun trigger to relieve pressure.
4	Choke lever in the NO CHOKE position.	Move choke to the CHOKE position.
5	Spark plug wire not attached.	Attach spark plug wire.
6	Engine ON/OFF switch in OFF position.	Place engine ON/OFF switch in ON position.
7	Choke lever in the CHOKE position on a <i>hot</i> engine or an engine that has been exposed to thermal heat for a long period of time.	Move choke to the NO CHOKE position.

(Troubleshooting Codes cont.)

CODE	POSSIBLE CAUSE	POSSIBLE SOLUTION
8	Fuel valve closed.	Move the fuel valve lever to the OPEN position.
9	Spray wand not in high pressure.	See Spray Wand Nozzles under <i>Operation</i> .
10	Low water supply.	Water supply must be at least 5 GPM @ 20 psi (138 kPa).
11	Leak at high-pressure hose fitting.	Repair leak. Apply sealant tape if necessary.
12	Nozzle obstructed.	See Nozzle Cleaning under <i>Maintenance</i> .
13	Water filter screen clogged.	Remove and clean filter.
14	Air in hose.	Turn off the engine, then the water source. Disconnect the water source from the pump inlet and turn the water source on to remove all air from the hose. When there is a steady stream of water present, turn water source off. Reconnect water source to pump inlet and turn on water source. Squeeze trigger to remove remaining air.
15	Choke lever in the CHOKE position.	Move choke to the NO CHOKE position.
16	High-pressure hose is too long.	Use high-pressure hose under 100 feet (30.48 m). Lengthen water supply hose instead of high-pressure hose.
17	Spray wand not in low pressure.	See Spray Wand Nozzles under <i>Operation</i> .
18	Chemical filter clogged.	Clean filter.
19	Chemical screen not in cleaning solution.	Make sure end of chemical hose is fully submerged into cleaning solution.
20	Chemical too thick.	Dilute chemical. Chemical should be the same consistency as water.
21	Worn seal or packing.	Have parts cleaned or replaced by authorized service center.
22	Chemical build up in chemical injector.	Have replaced by an authorized service center.
23	Worn or obstructed valves.	Have replaced by authorized service center.
24	Worn unloader piston.	Have replaced by authorized service center.
25	Worn or broken o-ring.	Check and replace.
26	Loose hose connection.	Tighten.
27	Piston packings worn.	Have replaced by authorized service center.
28	Pump head or tubes damaged from freezing.	Have replaced by authorized service center.

(Troubleshooting Codes cont.)

CODE	POSSIBLE CAUSE	POSSIBLE SOLUTION
29	Oil seals worn.	Have replaced by authorized service center
30	Loose drain plug.	Tighten.
31	Worn drain plug o-ring	Check and replace.
32	Worn fill plug o-ring.	Check and replace.
33	Pump overfilled.	Check for correct amount.
34	Incorrect oil used.	Drain and fill with correct amount and type of oil.
35	Vent plug is clogged.	Clean vent plug; blow air through it to remove any blockage. If problem persists, replace plug.
36	Air filter filled with oil.	Clean air filter element. Refer to engine instruction manual for correct procedure.

The FNA Group 1825 Greenleaf Avenue, Elk Grove Village, IL 60007
(DEC09) Part No. 7103369 DH4240B Copyright © 2009

The following are trademarks for one or more DEWALT power tools: the yellow and black color scheme; the “D” shaped air intake grill; the array of pyramids on the handgrip; the kit box configuration; and the array of lozenge-shaped humps on the surface of the tool.

DEWALT®, GUARANTEED TOUGH® and the yellow and black color scheme are trademarks the DEWALT Industrial Tool Co., used under license.

The FNA Group, 1825 Greenleaf Ave, Elk Grove Village, IL 60007, a licensee of DEWALT Industrial Tools